

1)

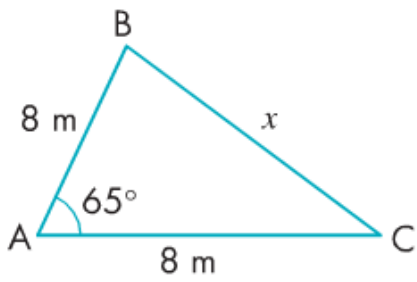

2)

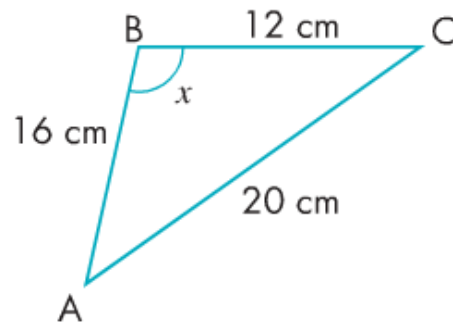

3)

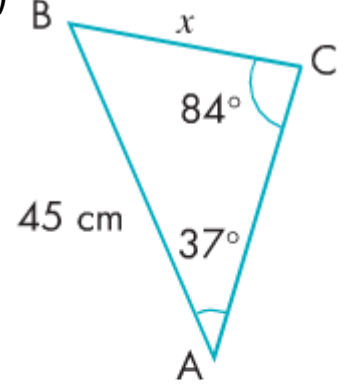

4)

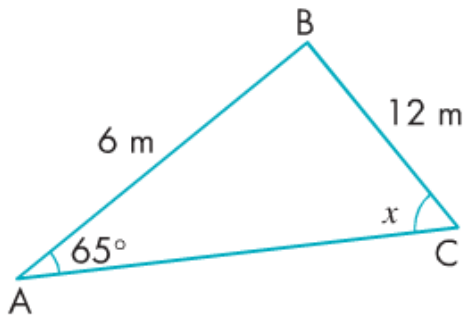

5)

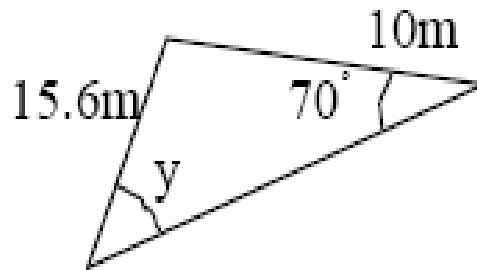

6)

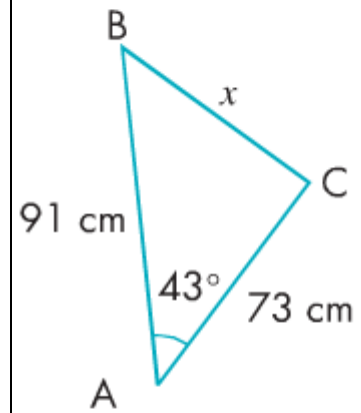

7)

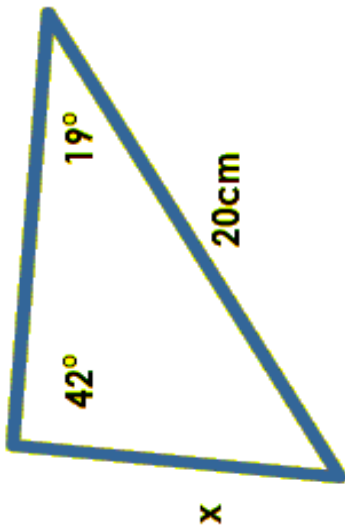

8)

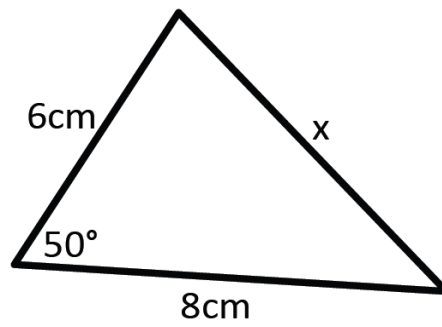

9)

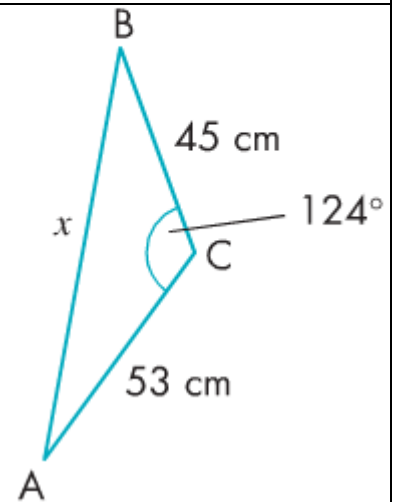

10)

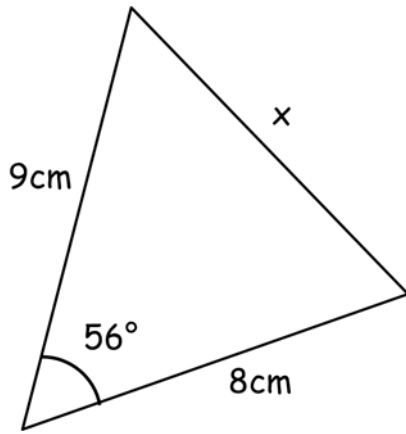

11)

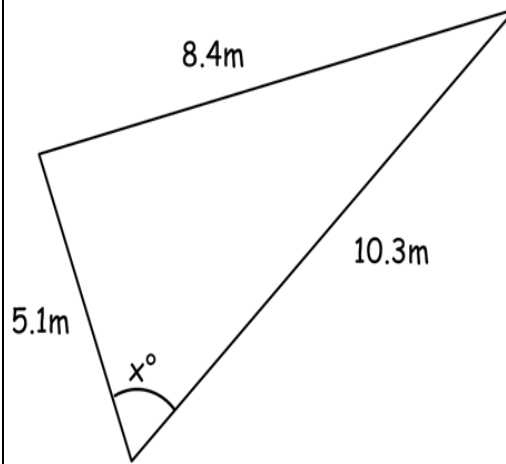

12)

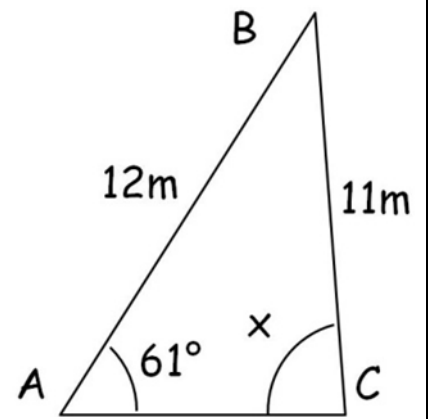

13)

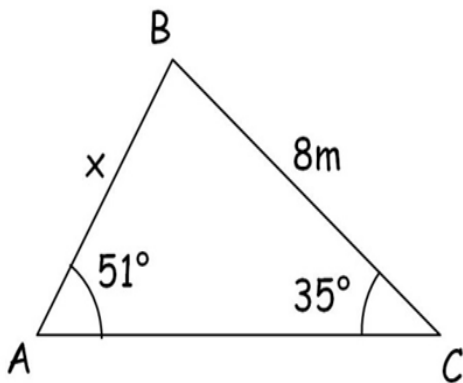

14)

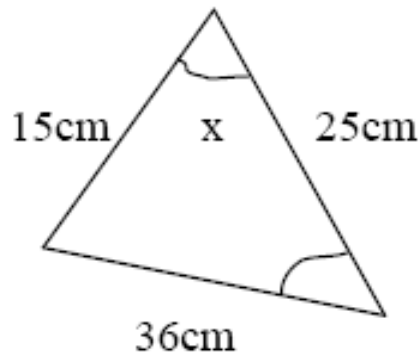

15)

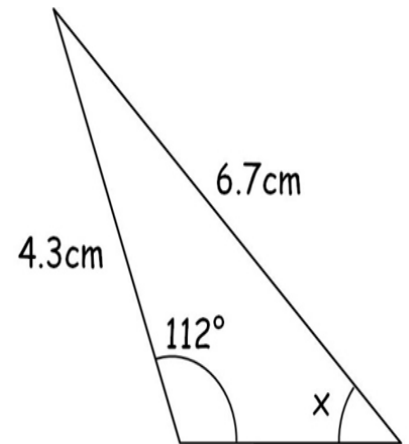

16)

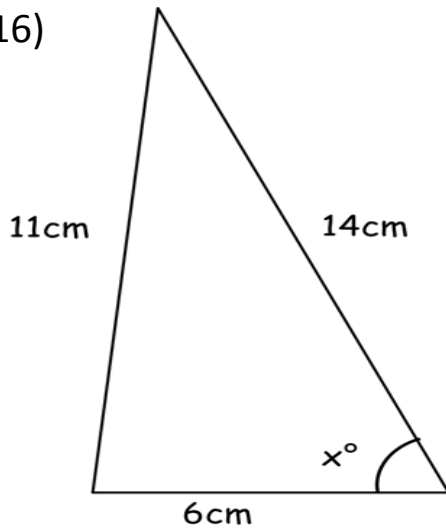

17)

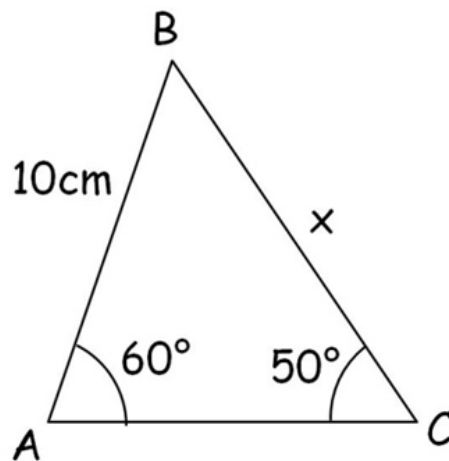

18)

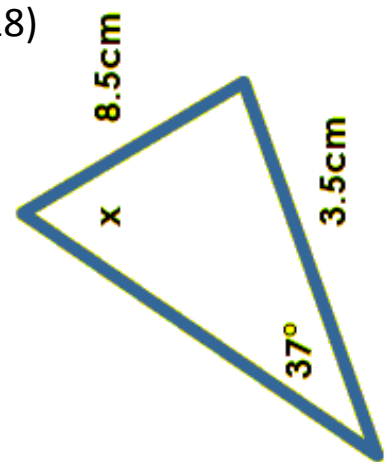

19)

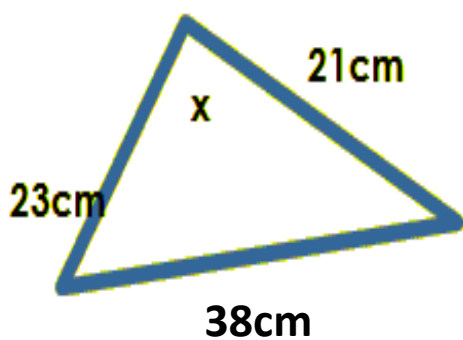

20)

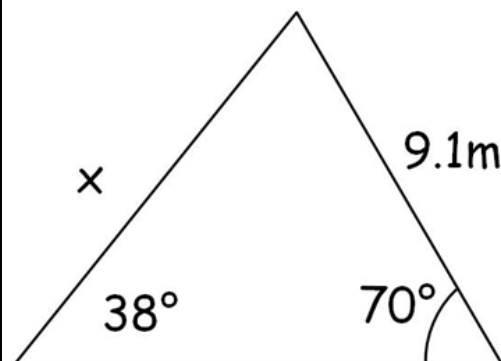

1)	Cosine Side	8.6
2)	Cosine Angle	90
3)	Sine Side	27.2
4)	Sine Angle	27
5)	Sine Angle	37
6)	Cosine Side	62.4
7)	Sine Side	9.7
8)	Cosine Side	6.2
9)	Cosine Side	86.6
10)	Cosine Side	8.03
11)	Cosine Angle	54
12)	Sine Angle	73 (or 107)
13)	Sine Side	5.9
14)	Cosine Angle	126
15)	Sine Angle	37
16)	Cosine Angle	49
17)	Sine Side	11.3
18)	Sine Angle	14
19)	Cosine Angle	119
20)	Sine Side	13.9